

↗ DOMETIC

CLIMATE CONTROL

IBIS4

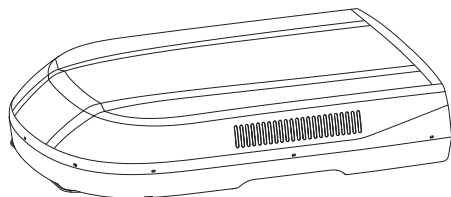

IB36H401RI, IB36H401RIY

EN

Air conditioning roof unit

Operating manual

Original instructions

Please read this instruction manual carefully before first use, and store it in a safe place. If you pass on the product to another person, hand over this instruction manual along with it.



You find the installation manual online at: "dometic.com/manuals".

The instructions in the installation manual are intended for qualified personnel at workshops who are familiar with the guidelines and safety precautions to be applied.

Table of contents

1	Explanation of symbols	4
2	Safety instructions	4
	2.1 General safety	5
	2.2 Operating the device safely	6
3	Target group for this manual	7
4	Intended use	7
5	Technical description	7
	5.1 Control panel	8
	5.2 Remote control	10
	5.3 Air conditioning modes	11
	5.4 Additional functions	12
6	Before initial use	13
7	Operating the roof air conditioner	13
	7.1 Basic notes on operation	13
	7.2 Using the remote control	14
	7.3 Hints for improved use	15
	7.4 Switching the roof air conditioner on and to stand-by	15
	7.5 Selecting the air conditioning mode	15
	7.6 Selecting the fan setting manually	16
	7.7 Setting the temperature	16
	7.8 Adjusting the air nozzles	17
	7.9 Setting the time	17

7.10	Activating the sleep function	18
7.11	Replacing the remote control batteries	18
7.12	Setting the timer	19
8	Cleaning the roof air conditioner	20
9	Maintenance of the roof air conditioner	22
10	Troubleshooting	23
11	Warranty	25
12	Disposal	25
13	Technical data	27

1 Explanation of symbols



WARNING!

Safety instruction: Indicates a hazardous situation that, if not avoided, could result in death or serious injury.



CAUTION!

Safety instruction: Indicates a hazardous situation that, if not avoided, could result in minor or moderate injury.



NOTICE!

Indicates a situation that, if not avoided, can result in property damage.



NOTE

Supplementary information for operating the product.

2 Safety instructions

The manufacturer accepts no liability for damage in the following cases:

- Damage to the product resulting from mechanical influences and incorrect connection voltage
- Alterations to the product without express permission from the manufacturer
- Use for purposes other than those described in the operating manual

In particular, the manufacturer will not be liable for any consequential damage, especially consequential damage caused by failure of the roof air conditioner.

2.1 General safety



WARNING!

- **Electrical devices are not toys.**

The appliance is not to be used by persons (including children) with reduced physical, sensory or mental capabilities, or lack of experience and knowledge, unless they are under supervision or have been given instruction.

- Children should be supervised to ensure that they do not play with the appliance.
- This appliance can be used by children aged from 8 years and above and persons with reduced physical, sensory or mental capabilities or lack of experience and knowledge if they are under supervision or have been given instruction concerning use of the appliance in a safe way and understand the hazards involved.
- Children shall not play with the appliance.
- Cleaning and user maintenance shall not be performed by children without supervision.
- Only use the device as intended.
- Do not make any alterations or conversions to the device.
- Installation, maintenance and repairs of the roof air conditioner may only be carried out by qualified personnel who are familiar with the risks involved when handling refrigerant and air conditioning systems as well as the relevant regulations. Inadequate repairs may cause serious hazards. For repair service, please contact the service centre in your country (addresses on the back page).
- Do not use the device near flammable fluids or in closed rooms.

- Make sure no combustible objects are stored or installed near the air outlet. A distance of at least 50 cm must be kept.
- Do not reach into air outlets or insert any foreign objects in the roof air conditioner.
- Do **not** undo the upper cover of the roof air conditioner in the event of a fire. Use approved extinguishing agents instead. Do not use water to extinguish fires.
- If the supply cord is damaged, it must be replaced by the manufacturer, its service agent or similarly qualified persons in order to avoid a hazard.

**NOTICE!**

- Never drive through automatic car washes when the roof air conditioner is mounted.
- Please ask your vehicle manufacturer if a technical inspection is required after fitting an air conditioner and whether the height entered in your vehicle documents needs to be altered.
- If faults occur in the roof air conditioner's refrigerant circuit, the roof air conditioner must be checked by a specialist company and properly repaired. The refrigerant must never be released into the air.

2.2 Operating the device safely

**WARNING!**

- Always disconnect the power supply when working on the device.

**NOTICE!**

- The roof air conditioner is not suitable for use in agricultural or construction vehicles.
- Operate the device only if you are certain that the housing and the cables are undamaged.

3 Target group for this manual

This operating manual is for the user of the roof air conditioner.

4 Intended use

The IBIS4 roof air conditioner is designed for installation on the roof of a caravan or recreational vehicle to provide reverse cycle heating and cooling. It is intended for vehicles with roofs with a thickness of 20 to 100 mm. The roof air conditioner must be installed so that it is within $\pm 10^\circ$ of the horizontal plane. It is **not** suitable for houses and apartments.

The roof air conditioner is **not** suitable for installation in construction machines, agricultural machines or similar equipment. It will not work properly if exposed to strong vibrations.

The function of the roof air conditioner is guaranteed for temperatures between -2°C and 52°C .

5 Technical description

The roof air conditioner supplies the interior with cool or warm air which is without dust and dirt and can be dehumidified.

The roof air conditioner is operated with the remote control or via the control panel on the air conditioner.



NOTE

The roof air conditioner can lower the temperature within the vehicle to a certain level. The temperature depends on the type of vehicle, the ambient temperature and the cooling capacity of your roof air conditioner.

Below an outer temperature of 16°C the roof air conditioner doesn't cool anymore. In this case only use the air conditioning mode "Ventilation" ({}).

5.1 Control panel

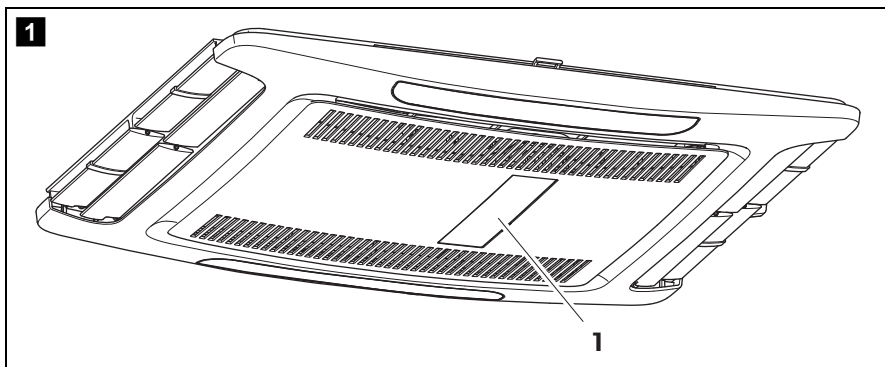

The control panel (1) is at the air outlet unit of the roof air conditioner.

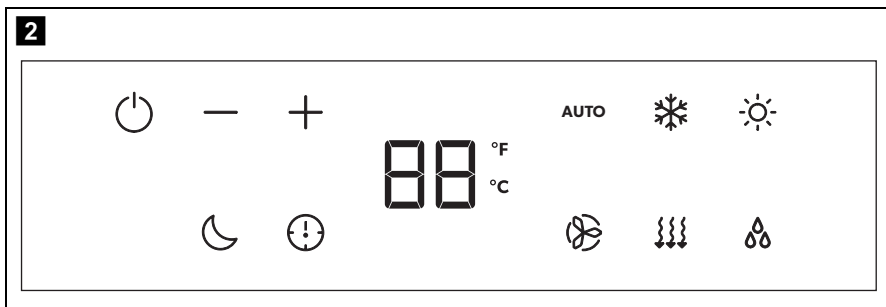

Control and display elements (fig. **2**):

Symbol	Explanation
	Switches the roof air conditioner on or to stand-by mode.
	+ button: Increases the currently displayed value. - button: Reduces the currently displayed value.
	Activates the sleep function (chapter "Additional functions" on page 12).
	Indicates the timer is set.
	Displays the set temperature and indicates fan level when fan is adjusted.
	Enables/disables automatic mode (chapter "Air conditioning modes" on page 11).
	Enables/disables cooling mode (chapter "Air conditioning modes" on page 11).
	Enables/disables heating mode (chapter "Air conditioning modes" on page 11).
	Adjusts the fan speed between Low, Med, High or Auto – showing as 1, 2, 3 or AA on the air outlet unit display for a short time when changed.
	Enables/disables ventilation mode (chapter "Air conditioning modes" on page 11). Circulates air without heating or cooling.
	Enables/disables dehumidification mode (chapter "Air conditioning modes" on page 11).





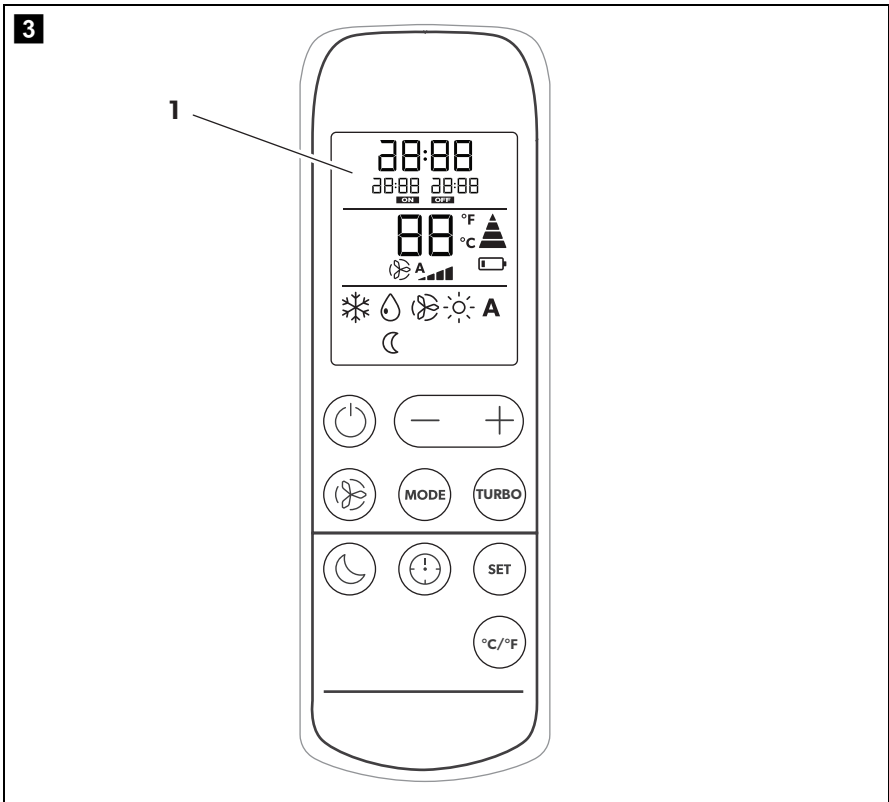



5.2 Remote control

All settings of the device (e. g. temperature settings, timer programming) are transmitted to the roof air conditioner by remote control.



The following control and display elements are available on the remote control (fig. **3**, page 10) :





No./Button	Explanation
1	<p>Display</p> <p>Displays the following:</p> <ul style="list-style-type: none"> • Time • Selected room temperature (target value) in °C or °F • Air conditioning mode • Fan level • Symbols for active additional functions • Battery status

No./Button	Explanation
	Switches the roof air conditioner on or to stand-by mode.
— +	+ button: Increases the currently displayed value. – button: Reduces the currently displayed value.
	Adjusts the fan speed between Low, Med or High – showing as 1, 2, 3 or AA on the air outlet unit display for a short time when changed.
	Selects the air operation mode (chapter “Air conditioning modes” on page 11).
	Selects the turbo mode. Sets the fan speed to Turbo speed to rapidly cool or heat the inside of the vehicle. After it is pressed again the fan will return to the previous setting.
	Activates the sleep function (chapter “Additional functions” on page 12).
	Sets the timer and the clock.
	Finishes timer and clock settings.
	Switches between temperature units Celsius (°C) and Fahrenheit (°F).

5.3 Air conditioning modes



The roof air conditioner has the following air conditioning modes:

Air conditioning mode	Display message	Explanation
Automatic	AUTO (on display) A (on remote control)	You specify the temperature, and the air conditioner brings the interior to this temperature by heating or cooling and by controlling the necessary fan speed.
Cooling		You specify the temperature and fan settings, and the air conditioner cools the interior to this temperature.

Air conditioning mode	Display message	Explanation
Heating		You specify the temperature and fan settings, and the air conditioner heats the interior to this temperature. The fan will only start after 2 min (on Low speed) and then after around 5 min will go to the set fan speed (after the evaporator reaches temperature).
Dehumidification	 (on display)  (on remote control)	Dehumidification removes moisture from the air without heating or cooling the inside. The fan speed is Low.
Ventilation	 (on display)  (on remote control)	The fan operates to circulate air without heating or cooling.

5.4 Additional functions

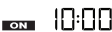
The roof air conditioner has the following additional functions:

Additional function	Display message	Explanation
Timer		The air conditioner is switched on at the specified time.
		The air conditioner is switched off at the specified time.
Sleep		The sleep function reduces the fan speed and the compressor speed to reduce the noise levels for easier sleeping.

6 Before initial use

Inspection before starting up

Before you switch on the roof air conditioner, observe the following:

- ▶ Check whether the supply voltage and frequency correspond to the values specified in the technical data (see leaflet).
- ▶ Ensure both the air intake opening and the air nozzles are free. All ventilation grilles must always be kept free to ensure that the roof air conditioner is able to operate at maximum capacity.



CAUTION! Beware of injury

Do not insert your fingers or objects into the air nozzles or the intake grille.

Set the time

- ▶ Set the current time (see chapter "Setting the time" on page 17).

Set the remote control

- ▶ Insert the batteries (see chapter "Replacing the remote control batteries" on page 18).
- ✓ The display shows all symbols for 5 seconds.
- ✓ The remote control is ready for operation.

7 Operating the roof air conditioner

7.1 Basic notes on operation

The roof air conditioner has three operating modes:

Operating mode	Features
Off	The roof air conditioner is switched off. The remote control is inactive.
Stand-by	The roof air conditioning is ready for operation and can be switched on with the remote control.
On	The roof air conditioner is conditioning the air in the interior.

You can use the **control panel** to

- switch the roof air conditioner to and from stand-by mode
- make the settings
- select additional functions

You can use the **remote control** to

- switch the roof air conditioner to and from stand-by mode.
- make the settings
- select additional functions

7.2 Using the remote control

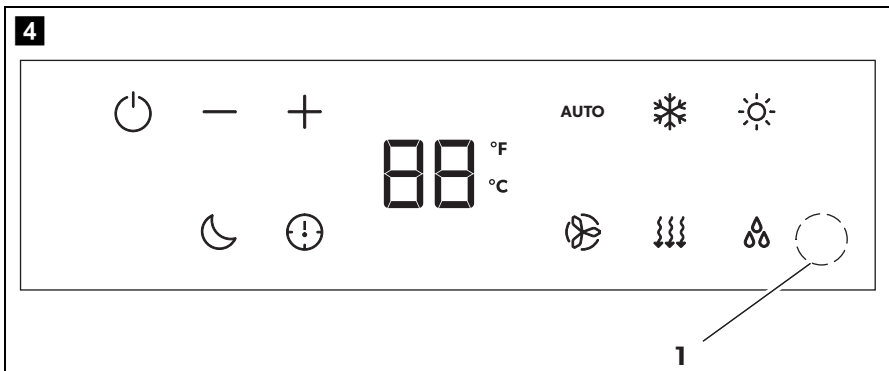

The remote control **must** be pointed at the IR receiver (1) on the control panel during operation.

- Press a button.
- ✓ The value is transmitted directly to the roof air conditioner.
- ✓ The roof air conditioner confirms the receipt of data with a high note.

Switching only the remote control to or from stand-by



In stand-by mode, the remote control display shows the time only.

If the remote control is not pointing to the IR receiver on the control panel, you can activate the remote control or switch it to stand-by independently from the roof air conditioner:

- Press the  button.

7.3 Hints for improved use

The following hints will optimise the performance of your roof air conditioner:



- Improve the heat insulation of your vehicle by sealing gaps and hanging reflective blinds or curtains on your windows.
- If the vehicle has been subjected to direct sunlight for a long time: Operate the roof air conditioner in the "Ventilation" () mode with the windows open for a while before switching on the "Cooling" () air conditioning mode.
- Avoid opening doors and windows as far as possible in the "Cooling" () mode.
- Align the air nozzles sensibly.
- Make sure the air nozzles and intake grille are not covered by cloths, paper or other objects.

7.4 Switching the roof air conditioner on and to stand-by



NOTE

- When roof air conditioner is switched on, it begins to condition the air to the values that were set most recently.
- The roof air conditioner can be switched off only by cutting mains power.
- You can use the remote control or the control panel to switch it on or to stand-by

- Press the  button.
- ✓ The roof air conditioner is switched on.
- Press the  button again to switch to stand-by.



7.5 Selecting the air conditioning mode

- Select the desired air conditioning mode using the **MODE** button, see chapter "Air conditioning modes" on page 11.
- ✓ The roof air conditioner confirms the receipt of the values with a high note.
- ✓ The roof air conditioner is switched to the selected air conditioning mode.

7.6 Selecting the fan setting manually

The fan controls the strength of the air supply.

In all modes, except for the "Automatic" (**A**) mode, the fan speed can be selected manually.

Display message		Explanation
Remote control	ADB	
	1, 2, 3	Three fan speeds
	AA	Auto fan (changes the fan speed based on the temperature setting and actual room temperature) only available in the "Cooling" (❄️), "Heating" (🔥) and "Ventilation" (🌀) modes.
	4	Turbo fan speed, only when TURBO button is pressed only available in the "Cooling" (❄️) and "Heating" (🔥) modes.

- Use the  button to select the desired fan speed.
- ✓ The roof air conditioner confirms the receipt of the values with a high note.
- ✓ The new fan speed is set.

7.7 Setting the temperature

Cooling Mode

In the "Automatic" (**A**), "Cooling" (❄️), and "Dehumidifying" (🌀) modes, you can specify a temperature between 16 °C and 30 °C via the remote control.

- Use the **+** or **-** button to select the desired temperature.
- ✓ The roof air conditioner confirms the receipt of the values with a high note.
- ✓ The temperature is set on the roof air conditioner.

Heating Mode

In the "Automatic" (**A**) and "Heating" (🔥) modes, you can specify a temperature between 16 °C and 30 °C via the remote control.

- Use the **+** or **-** button to select the desired temperature.

- ✓ The roof air conditioner confirms the receipt of the values with a high note.
- ✓ The temperature is set on the roof air conditioner.

7.8 Adjusting the air nozzles

The air supply within the vehicle can be regulated by setting the air nozzles.

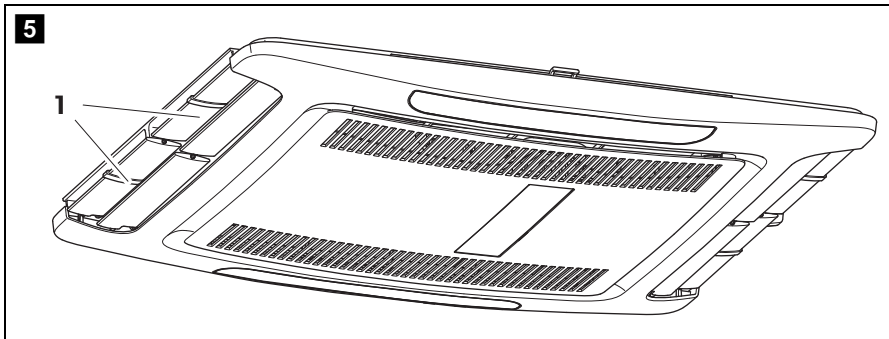

- Turn the slats (**1**) in the air nozzles independently in the required directions. The air flow can be adjusted along the ceiling or towards the floor.

7.9 Setting the time

The remote control needs the current time in order to program the timer. The time is indicated on the display of the remote control in 24 hour format.

Perform the following steps to set the time:



NOTE

The remote control returns to its initial mode and saves the current setting, if no key is pressed on the remote control for 15 seconds while setting the time.

- Press and hold ⏸ the button for 2 s.
- ✓ The time flashes on the display of the remote control.
- Use the **+** or **-** button to set the current time.
Press the longer than 2 s to increase or decrease the time quicker.
- Press the **SET** button to confirm the time.

7.10 Activating the sleep function



NOTE

The sleep function is only available in "Cooling" and "Heating" mode.

When the sleep function is activated, the compressor speed and the fan speed is limited to a lower level to reduce the noise levels for easier sleeping.

- Set the required temperature (see chapter "Setting the temperature" on page 16).
- Press the ☾ button.
- ✓ The ☾ symbol appears in the display.
The sleep function is activated.
- To deactivate the sleep function press the ☾ button again.



NOTE

The sleep function is deactivated if the **MODE** button is pressed.

7.11 Replacing the remote control batteries

Replace the batteries if you see the  symbol on the display.

The battery compartment is on the back of the remote control.

- Gently push down the lid of the battery compartment and slide it open in the direction of the arrow.
- Insert the new batteries (2x type AAA) in the remote control as indicated in the battery compartment.
- Close the cover of the battery compartment.



Protect the environment!

Do not dispose of batteries with general household waste.
Return any used batteries to your retailer or take them to a collection point.

7.12 Setting the timer

The timer function allows you to set a specific time period for air conditioning. You can specify the switch-on time, the switch-off time or both values.





NOTE



The remote control returns to its initial mode if no button is pressed on the remote control for 15 seconds while programming the timer.

- Before programming the timer, select the air conditioning mode and all required values (e.g. temperature).



Setting the switch-on time

- Press the  button once.
- ✓ The **ON** symbol () flashes on the display of the remote control.
- Use the **+** or **-** button to set the time when the air conditioner will be switched on.
- Press the **SET** button to transmit the value to the roof air conditioner.
- ✓ The switch-on time is set on the roof air conditioner.
The roof air conditioner is switched on with the selected air conditioning mode at the specified time.

Setting the switch-off time

- Press the  button twice.
- ✓ The **OFF** symbol () flashes on the display of the remote control.
- Use the **+** or **-** button to set the time when the air conditioner will be switched off.
- Press the **SET** button to transmit the value to the roof air conditioner.
- ✓ The switch-off time is set on the roof air conditioner.
The roof air conditioner runs in the selected air conditioning mode until the specified time.
- Switch the roof air conditioner to stand-by.

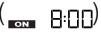
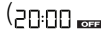
Setting the switch-on and switch-off times

- Press the  button three times.
- ✓ The **ON** symbol () flashes on the display of the remote control.
The **OFF** symbol () is displayed.
- ✓ Use the **+** or **-** button to set the time when the roof air conditioner is to switch on.
- Press the  button again.
- ✓ The **OFF** symbol () flashes on the display of the remote control.
- Use the **+** or **-** button to set the time when the roof air conditioner is to switch off.
- Press the **SET** button to transmit the value to the roof air conditioner.
- ✓ The switch-on and switch-off times are set on the roof air conditioner.
- ✓ The roof air conditioner starts in the selected air conditioning mode at the specified time and runs until the second specified time.
- Switch the roof air conditioner to stand-by.

Cancelling timer settings

If you have set the timer, you can cancel these settings as follows:

- Press the  button four times.
- ✓ The timer symbol disappears.
- ✓ The setting has been cancelled.

8 Cleaning the roof air conditioner



NOTICE! Beware of damage

- Do not clean the roof air conditioner with a high-pressure cleaner. Exposure to water can damage the air conditioner.
- Do not use sharp or hard objects or cleaning agents for cleaning as these may damage the roof air conditioner.
- To clean the roof air conditioner, use water with a gentle cleaning agent. Never use petrol, diesel or solvents.

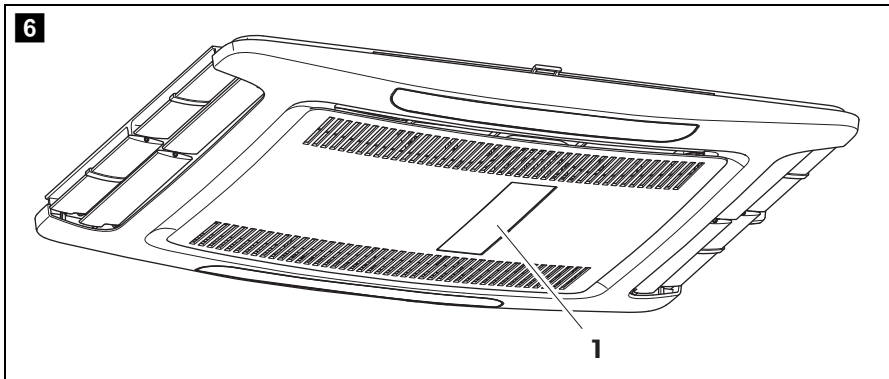

NOTICE! Beware of damage

The air outlet unit display screen (1) is acrylic and can be damaged by some common household chemicals.

Only use a mild solution of warm soapy water to clean it.

Chemical cleaners, window cleaners, alcohol, certain tensides, organic solvents, softeners and similar can damage the display.

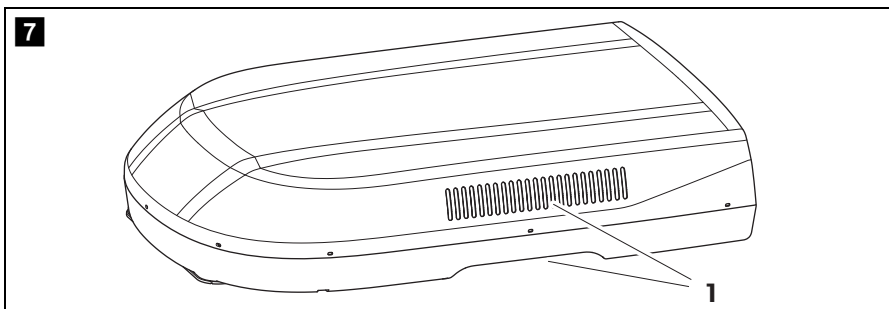

- Regularly remove leaves and other dirt from the ventilation grilles (1) of the roof air conditioner. Make sure you do not damage the grilles in the process.
- Clean the housing of the roof air conditioner and the air outlet unit occasionally with a damp cloth.
- Clean the remote control with a slightly damp cloth from time to time. We recommend using a cleaning cloth for glasses to clean the display.

9 Maintenance of the roof air conditioner



WARNING!

Any other maintenance work to that which is described here may only be carried out by qualified personnel who are familiar with the risks involved when handling refrigerant and air conditioning systems as well as the relevant regulations.

Interval

Inspection/maintenance

Regularly

Check the condensation water drainage:

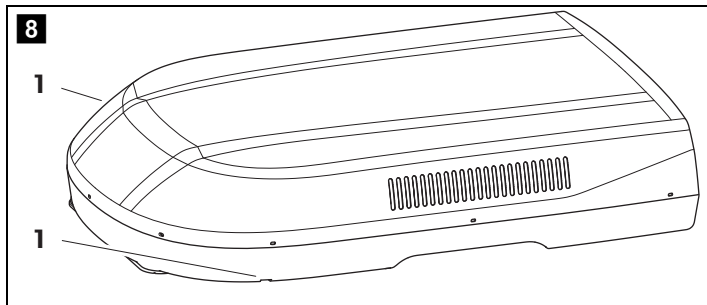

- Check whether the condensation water drainage channels (1) at the sides of the roof air conditioner are clear and the condensation water is able to escape.

Regularly

Clean the filter of the air discharge unit:

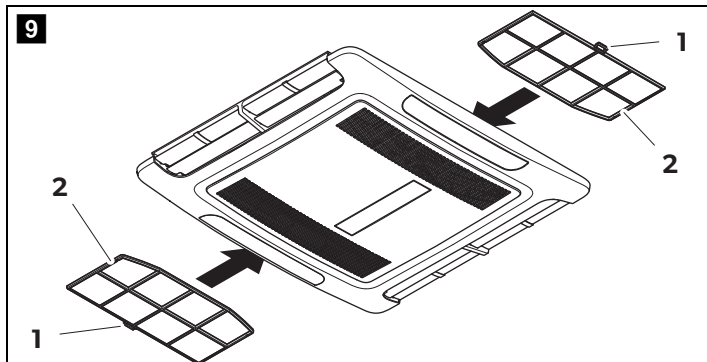

- Insert a flat screwdriver or knife into the handle (1) to pull the filters (2) slightly out.
- Remove the filters by hand.
- Clean the filters with a detergent solution and let it dry.
- Slide the dry filters back in.

Interval	Inspection/maintenance
Once per year	Check the profile seals: <ul style="list-style-type: none"> ► Check the seal between the roof air conditioner and the roof of the vehicle for cracks and other damage.
Once per year	Have the heat exchanger serviced: <ul style="list-style-type: none"> ► Have the heat exchanger of the roof air conditioner serviced by specialist workshop.
Once per year	Check the fastening bolt tightness: <ul style="list-style-type: none"> ► Check the fastening bolts are tightened to the correct torque and adjust if necessary.

10 Troubleshooting

Problem	Cause	Remedy
Roof air conditioner constantly switches itself off.	Icing sensor has tripped.	Outer temperature is too low or all air nozzles are closed.
Not cooling well	The roof air conditioner is not set to cooling.	► Set the roof air conditioner to cooling.
	The ambient temperature is above 52 °C.	The roof air conditioner is only designed for ambient temperatures of up to 52 °C.
	The temperature set is higher than the room temperature.	► Select a lower temperature.
	The ambient temperature is below 16 °C.	The roof air conditioner is designed for cooling only at ambient temperatures above 16 °C.
	One of the temperature sensors is defective.	► Contact an authorised service agent or Dometic.
	The evaporator fan is damaged.	
The condenser fan is damaged.		

Problem	Cause	Remedy
Not heating well	The roof air conditioner is not set to heating.	➤ Set the roof air conditioner to heating.
	The ambient temperature is below -2 °C.	The roof air conditioner is designed for best operation at ambient temperatures above -2 °C.
	The temperature set is lower than the room temperature.	➤ Select a higher temperature.
	One of the temperature sensors is defective.	➤ Contact an authorised service agent or Dometic.
	The evaporator fan is damaged.	
	The condenser fan is damaged.	
Low air output	The air intake grilles are blocked or obstructed.	➤ Remove any leaves and other dirt from the ventilation grilles of the roof air conditioner.
	The fan is defective.	➤ Contact an authorised service agent or Dometic.
Water enters the vehicle.	The condensation water drainage openings are clogged up.	➤ Clean the drainage openings for condensation water.
	The seals are damaged.	➤ Contact an authorised service agent or Dometic.
Roof air conditioner does not switch on.	No supply voltage (240 V AC) connected.	➤ Check the power supply.
	The voltage is too low (under 200 V AC).	➤ Contact an authorised service agent or Dometic.
	The voltage converter is defective.	
	One of the temperature sensors is defective.	
	The electrical fuse of the power supply is too low.	➤ Check the electrical fuse of the power supply.
Roof air conditioner does not switch off.	One of the temperature sensors is defective.	➤ Contact an authorised service agent or Dometic.
	The electrical fuse of the power supply is too low.	➤ Check the electrical fuse of the power supply.

Problem	Cause	Remedy
Remote control does not register.	The remote control is not pointing towards the air outlet unit display.	➤ Point the remote control towards the air outlet unit display.
	The batteries in the remote control are empty.	➤ Replace the batteries in the remote control.

11 Warranty

The statutory warranty period applies. If the product is defective, please contact the service partner in your country (addresses on the back of the instruction manual).

Our experts will be happy to help you and will discuss the warranty process with you in more detail.

12 Disposal

Regulations for environmental safety and correct disposal

All organisations must apply a set of procedures to identify, evaluate and control the influence that their activities (manufacturing, products, services, etc.) have on the environment.

The procedures to be followed to identify significant environmental impact must take the following factors into account:

- use of raw materials and natural resources
- atmospheric emissions
- discharge of liquids
- waste management and recycling
- contamination of the soil

In order to minimise environmental impact, the manufacturer provides a series of indications here below that should be taken into account by all those who, for whatever reason, interact with the appliance during its working life.

- All packing components must be disposed of (preferably recycled) in compliance with statutory legislation in the country in which disposal takes place.
- All product components must be disposed of (preferably recycled) in compliance with statutory legislation in the country in which disposal takes place.

- For correct disposal, the appliance must be consigned to an authorised waste disposal company to ensure that all recyclable components are reused and the remaining materials are processed properly.
- During installation ensure the room has adequate ventilation to prevent the build-up of stale air that might be harmful to the health of the operators.
- During operation and maintenance ensure that any waste pollutant products (oil, grease, etc.) are disposed of correctly.
- Keep noise levels down to reduce noise pollution.

For more information on correct dismantling of our products please refer to the recycling handbooks at dometic.com.

- Place the packaging material in the appropriate recycling waste bins wherever possible.
- When in operation or undergoing repairs and maintenance work, make sure that the refrigerant circuit is not damaged and refrigerant cannot escape. It acts as a greenhouse gas and should not be allowed into the environment.



If you wish to finally dispose of the product, ask your local recycling centre or specialist dealer for details about how to do this in accordance with the applicable disposal regulations.

- Dispose of the product at an official waste disposal facility in accordance with the applicable recycling or disposal guidelines.



Protect the environment!

Do not dispose of any batteries with general household waste. Return defective or used batteries to your retailer or dispose of them at collection points.

Any person who handles or works on equipment containing refrigerant in Australia must have an appropriate refrigerant handling license.



This includes:

- decanting the refrigerant
- manufacturing, installing, commissioning, servicing or maintaining equipment regardless of whether it is charged with refrigerant or not
- decommissioning or disposing of equipment where refrigerant is present

Discharge of refrigerant into the atmosphere is against the law. Severe penalties apply.

13 Technical data

Contains fluorinated greenhouse gases. Hermetically sealed equipment.

	IBIS4 IB36H401RI, IB36H401RIY
Compressor capacity:	3600 W
Cooling capacity based on ISO 5151:	2625 W
Heating capacity based on ISO 5151:	3017 W
Rated input voltage:	220 – 240 V~/ 50 Hz
Rated current in cooling mode:	6.9 A
Rated current in heating mode:	6.5 A
Required fuse:	10 A
Operating temperature range:	-2 °C to +52 °C
Refrigerant:	R-410A
Refrigerant quantity:	0.750 kg
CO ₂ equivalent:	1.566 t
Global warming potential (GWP):	2088
Protection class (outdoor unit):	IPX4
Suggested max. vehicle length (with insulated walls):	< 7 m
Dimensions L x W x H (height above vehicle roof):	1112 x 758 x 230 mm
Total installed weight:	40 kg
Inspection/certification:	 

Mobile living made easy.



dometic.com

**YOUR LOCAL
DEALER**

dometic.com/dealer

**YOUR LOCAL
SUPPORT**

dometic.com/contact

**YOUR LOCAL
SALES OFFICE**

dometic.com/sales-offices

A complete list of Dometic companies, which comprise the Dometic Group, can be found in the public filings of:
DOMETIC GROUP AB Hemvärnsgatan 15 SE-17154 Solna Sweden